

## General Description

The TD1602 is a series of easy to use fixed and adjustable step-down(buck) switch-mode voltage regulators. These devices are available in fixed output voltage of 5V, and an adjustable output version. Both versions are capable of driving a 3A load with excellent line and load regulation.

Requiring a minimum number of external components, these regulators are simple to use and include internal frequency compensation, and a fixed-frequency oscillator.

The output voltage is guaranteed to  $\pm 3\%$  tolerance under specified input voltage and output load conditions. The oscillator frequency is guaranteed to  $\pm 15\%$ . External shutdown is included, featuring typically 80  $\mu\text{A}$  standby current. Self protection features include a two stage frequency reducing current limit for the output switch and an over temperature shutdown for complete protection under fault conditions.

The TD1602 is available in TO-263-5L packages.

## Features

- 5V and adjustable output versions
- Output adjustable from 1.23v to 57V
- Fixed 52KHz frequency internal oscillator
- Guaranteed 3A output load current
- Input voltage range up to 60V
- TTL shutdown capability
- Excellent line and load regulation
- High efficiency
- Thermal shutdown and current limit protection
- Available in TO-263 packages

## Package Types

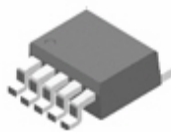

Figure 1. Package Types of TD1602

## Applications

- Simple High-efficiency step-down regulator
- On-card switching regulators
- Positive to negative converter
- LCD monitor and LCD TV
- DVD recorder and PDP TV
- Battery charger
- Step-down to 3.3V for microprocessors

### Pin Configurations

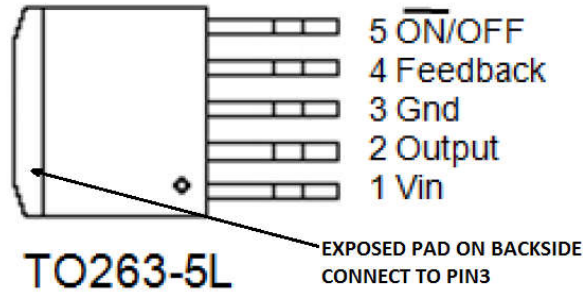
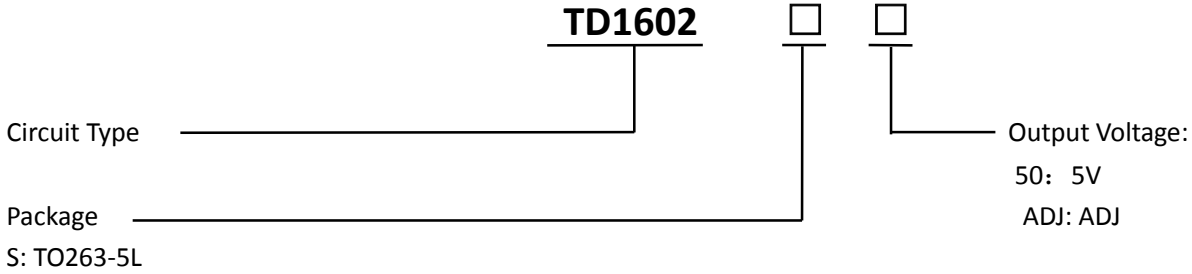

Figure 2. Pin Configuration of TD1602 (Top View)

### Pin Description

Pin Number	Pin Name	Description
1	Vin	Input supply voltage
2	Output	Switching output
3	GND	Ground
4	FB	Output voltage feedback
5	ON/OFF	ON/OFF shutdown. Active is "Low" or floating

Ordering Information



Function Block

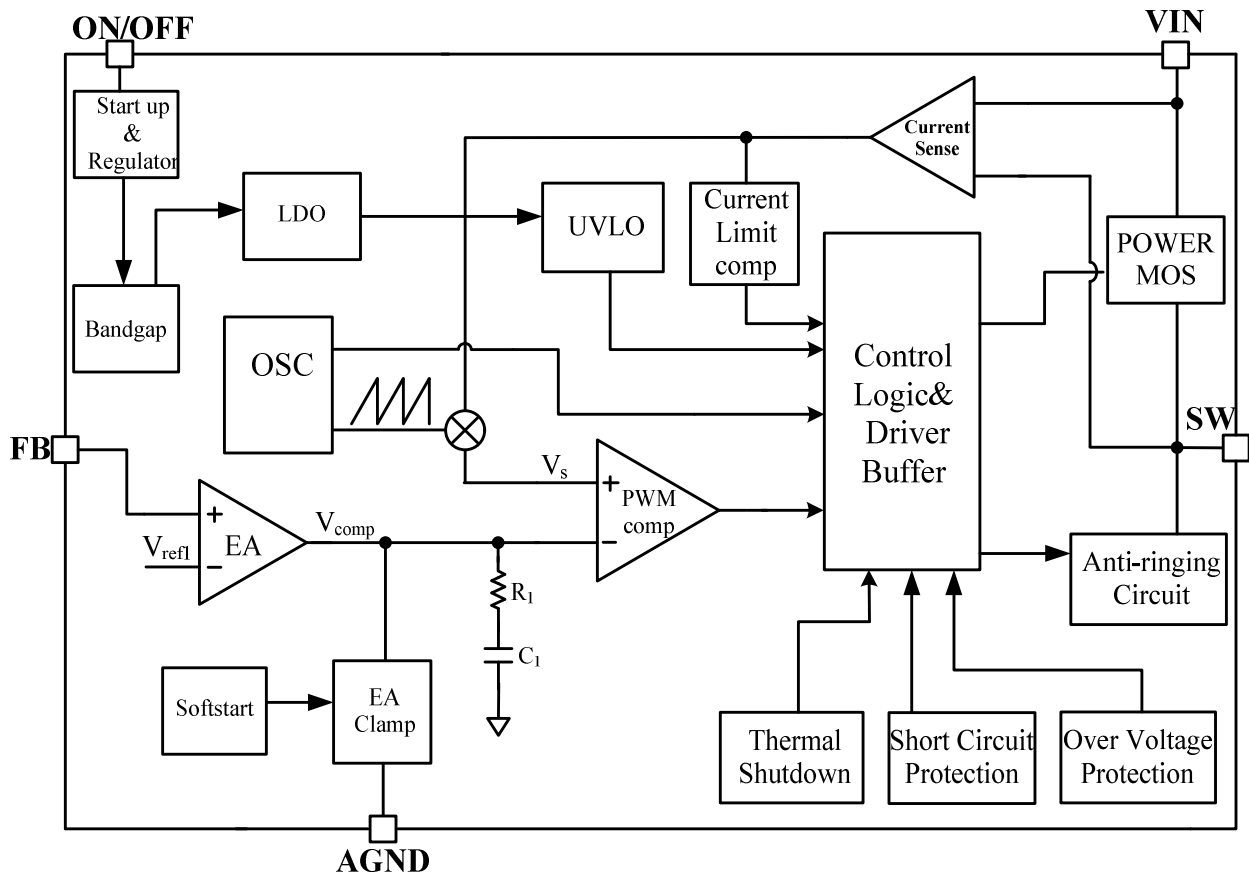

Figure3. Function Block Diagram of TD1602

## Absolute Maximum Ratings

**Note:** Stresses greater than those listed under Maximum Ratings may cause permanent damage to the device. This is a stress rating only and functional operation of the device at these or any other conditions above those indicated in the operation is not implied. Exposure to absolute maximum rating conditions for extended periods may affect reliability.

Parameter	Symbol	Value	Unit
Input Voltage	$V_{IN}$	-0.3 to 63	V
Feedback Pin Voltage	$V_{FB}$	-0.3 to 5	V
ON/OFF Pin Voltage	$V_{EN}$	-0.3 to 5	V
Output Pin Voltage	$V_{SW}$	-0.3 to $V_{in}+0.3$	V
Power Dissipation	$P_D$	Internally limited	mW
Operating Junction Temperature	$T_J$	150	°C
Storage Temperature	$T_{STG}$	-65 to 150	°C
Lead Temperature (Soldering, 10 sec)	$T_{LED}$	260	°C
ESD (HBM)		2000	V
MSL		Level3	
Thermal Resistance-Junction to Ambient	$R_{\theta JA}$	23	°C / W
Thermal Resistance-Junction to Case	$R_{\theta JC}$	3.5	°C / W

## Recommended Operation Conditions (Note3)

Parameter	Symbol	Min.	Max.	Unit
Input Voltage	$V_{IN}$	9	60	V
Output voltage	$V_{out}$	1.23	50	V
Converter output current	$I_{out}$	0	3	A
Operating Junction Temperature	$T_J$	-40	125	°C
Operating Ambient Temperature	$T_A$	-40	85	°C

## Electrical Characteristics

V<sub>IN</sub> =12V, T<sub>A</sub> =+25°C, unless otherwise noted

Parameter	Symbol	Condition	Min	Typ	Max	Units
Shutdown Supply Current		ON/OFF=5V	-	35	-	uA
Quiescent current	I <sub>Q</sub>	ON/OFF=0V;V <sub>FB</sub> =1.5V	-	5	-	mA
Feedback Voltage	V <sub>FB</sub>	9V ≤ V <sub>IN</sub> ≤ 60V	1.200	1.23	1.26	V
Oscillation Frequency	F <sub>OSC1</sub>	V <sub>FB</sub> >0.3	42	52	62	kHz
Highside Switch On Resistance	R <sub>DS(ON)</sub>		-	350	-	mΩ
Current Limit	I <sub>L</sub>	Peak output current	-	4.2	-	A
Maximum Duty Cycle	D <sub>MAX</sub>		-	99	-	%
ON/OFF Threshold voltage	V <sub>IL</sub>	Low(Regulator ON)	-	0.8	-	V
Input Under Voltage Lockout Threshold		V <sub>IN</sub> Rising	-	8.6	-	V
Input Under Voltage Lockout Threshold Hysteresis			-	600	-	mV
Thermal Shutdown			-	150	-	°C

Typical Application Circuit

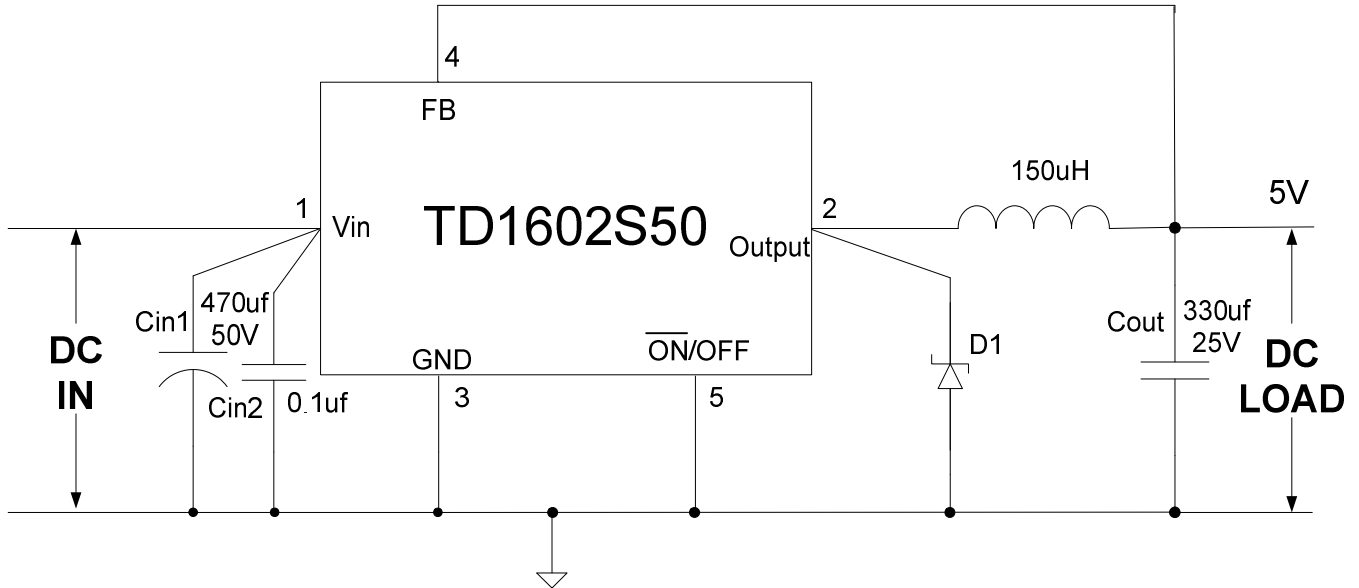

Figure 11. Typical Application of TD1602 For 5V

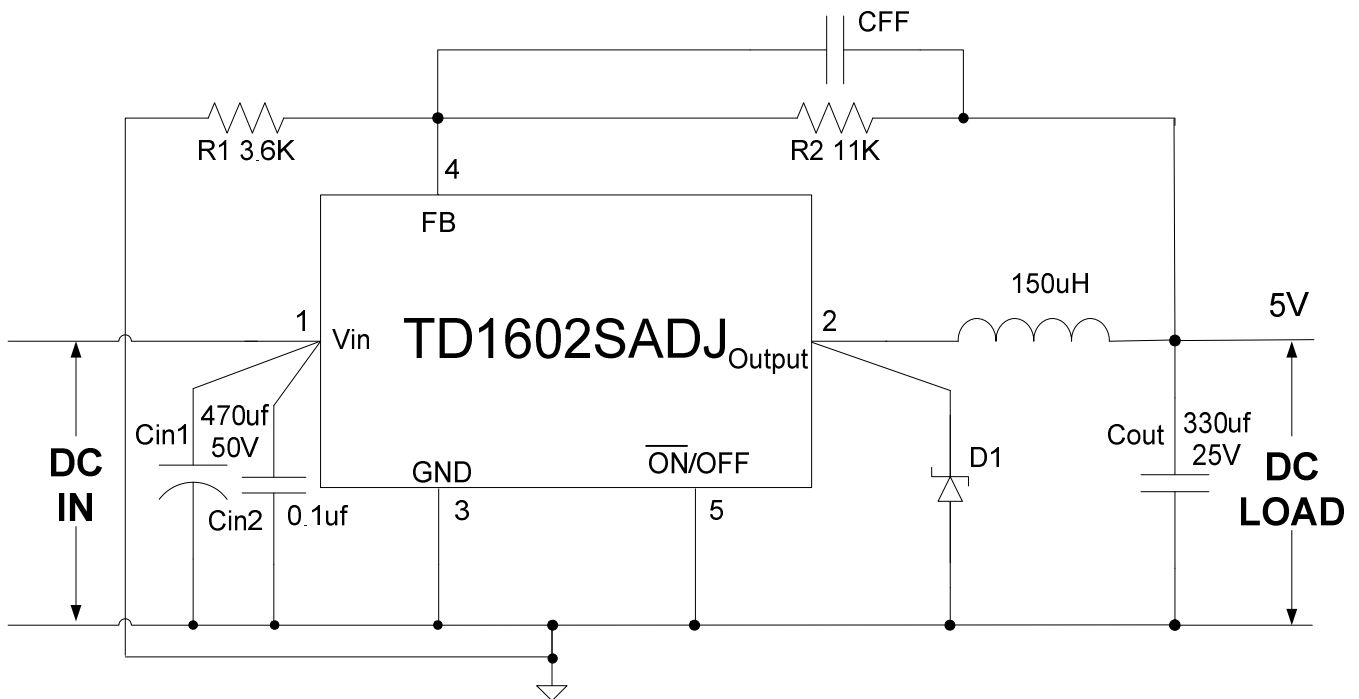

Figure 12. Typical Application of TD1602 For ADJ

## Function Description

The TD1602 regulates input voltages from 9V to 60V down to an output voltage as low as 1.23V, and supplies up to 3A of load current.

The TD1602 uses current-mode control to regulate the output voltage. The output voltage is measured at FB through a resistive voltage divider and amplified through the internal trans-conductance error amplifier. The output voltage of the error amplifier is compared to the switch current (measured internally) to control the output voltage.

### Setting the Output Voltage

The output voltage is set using a resistive voltage divider connected from the output voltage to FB. The voltage divider divides the output voltage down to the feedback voltage by the ratio:

$$V_{FB} = V_{OUT} \times \left( \frac{R_2}{R_1 + R_2} \right)$$

Thus the output voltage is:

$$V_{OUT} = 1.23 \times \left( \frac{R_1 + R_2}{R_2} \right)$$

### Inductor

The inductor is required to supply constant current to the load while being driven by the switched input voltage. A larger value inductor will result in less ripple current that will in turn result in lower output ripple voltage. However, the larger value inductor will have a larger physical size, higher series resistance, and/or lower saturation current. A good rule for determining inductance is to allow the peak-to-peak ripple current to be approximately 30% or the maximum switch current limit. Also, make sure that the peak inductor current is below the maximum switch current limit.

The inductance value can be calculated by:

$$L = \frac{V_{OUT}}{f_s \times \Delta I_L} \times \left( 1 - \frac{V_{OUT}}{V_{IN}} \right)$$

Where  $V_{OUT}$  is the output voltage,  $V_{IN}$  is the input voltage,  $f_s$  is the switching frequency, and  $\Delta I_L$  is the peak-to-peak inductor ripple current.

Choose an inductor that will not saturate under the maximum inductor peak current, calculated by:

$$L_P = I_{LOAD} + \frac{V_{OUT}}{2 \times f_s \times L} \times \left( 1 - \frac{V_{OUT}}{V_{IN}} \right)$$

where  $I_{LOAD}$  is the load current.

The choice of which style inductor to use mainly depends on the price vs. size requirements and any EMI constraints.

### Input Capacitor

The input current to the step-down converter is discontinuous, therefore a capacitor is required to supply the AC current while maintaining the DC input voltage. Use low ESR capacitors for the best performance. Ceramic capacitors are preferred, but tantalum or low-ESR electrolytic capacitors will also suffice. Choose X5R or X7R dielectrics when using ceramic capacitors. Since the input capacitor (C1) absorbs the input switching current, it requires an adequate ripple current rating. The RMS current in the input capacitor can be estimated by:

$$I_{C1} = I_{LOAD} \times \sqrt{\frac{V_{OUT}}{V_{IN}} \times \left( 1 - \frac{V_{OUT}}{V_{IN}} \right)}$$

The worst-case condition occurs at  $V_{IN}=2V_{OUT}$ , where  $I_{C1} = I_{LOAD}/2$ . For simplification, use an input capacitor with a RMS current rating greater than half of the maximum load current. The input capacitor can be electrolytic, tantalum or ceramic. When using electrolytic or tantalum capacitor, be placed as close to the IC as possible. When using ceramic capacitors, make sure that they have enough capacitance to provide sufficient charge to prevent excessive voltage ripple at input. The input voltage ripple for low ESR capacitors can be estimated by:

$$\Delta V_{IN} = \frac{I_{LOAD}}{C_1 \times f_s} \times \frac{V_{OUT}}{V_{IN}} \left( 1 - \frac{V_{OUT}}{V_{IN}} \right)$$

where  $C_1$  is the input capacitance value.

### Output Capacitor

The output capacitor (C2) is required to maintain the DC

output voltage. Ceramic, tantalum, or low ESR electrolytic capacitors are recommended. Under typical application conditions, a minimum ceramic capacitor value of 20μF is recommended on the output. Low ESR capacitors are preferred to keep the output voltage ripple low. The output voltage ripple can be estimated by:

$$\Delta V_{OUT} = \frac{V_{out}}{f_s \times L} \times \left(1 - \frac{V_{out}}{V_{in}}\right) \times \left(R_{ESR} + \frac{1}{8 \times f_s \times C2}\right)$$

Where C2 is the output capacitance value and RESR is the equivalent series resistance (ESR) value of the output capacitor.

When using ceramic capacitors, the impedance at the switching frequency is dominated by the capacitance which is the main cause for the output voltage ripple. For simplification, the output voltage ripple can be estimated by:

$$\Delta V_{OUT} = \frac{V_{OUT}}{8 \times f_s^2 \times L \times C2} \times \left(1 - \frac{V_{OUT}}{V_{IN}}\right)$$

When using tantalum or electrolytic capacitors. The ESR dominates the impedance at the switching frequency. For simplification, the output ripple can be approximated to:

$$\Delta V_{OUT} = \frac{V_{OUT}}{f_s \times L} \times \left(1 - \frac{V_{OUT}}{V_{IN}}\right) \times R_{ESR}$$

The characteristics of the output capacitor also affect the stability of the regulation system. The TD1602 can be optimized for a wide range of capacitance and ESR values.

## Layout Consideration

- 1. Input MLCC capacitor is strongly recommended to added and should be connected to the VIN pin and the GND pin as close as possible.**
2. Keep sensitive signal traces such as trace connecting FB pin away from the VOUT pins.
3. Make the current trace from SW pin to inductor to the GND as short as possible.
4. Pour a maximized copper area to the GND pin and the VIN pin to help thermal dissipation.



Package Information

T0263-5L Package Outline Dimensions

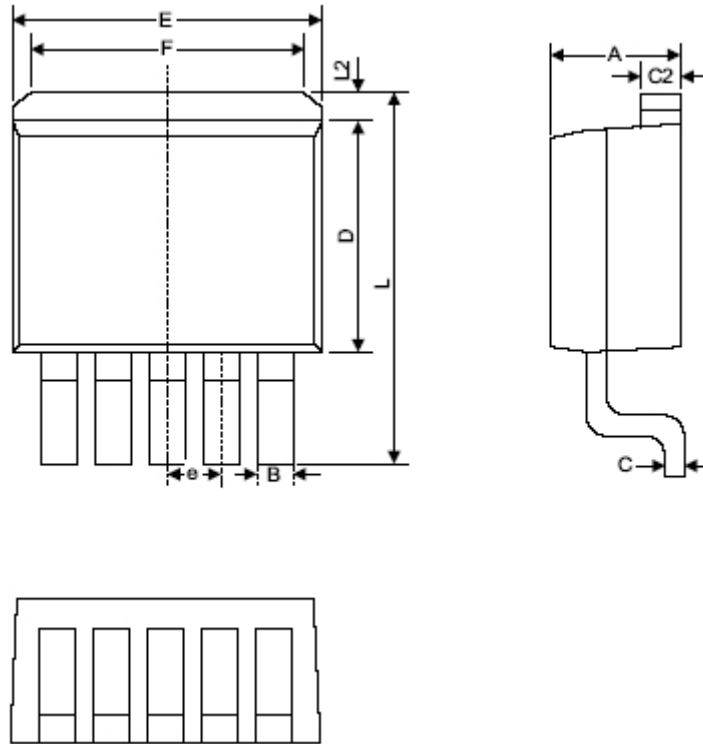

Symbol	Dimensions In Millimeters		Dimensions In Inches	
	Min.	Max.	Min.	Max.
A	4.06	4.83	0.160	0.190
B	0.76	1.02	0.030	0.040
C	0.36	0.64	0.014	0.025
C2	1.14	1.40	0.045	0.055
D	8.64	9.65	0.340	0.380
E	9.78	10.54	0.385	0.415
e	1.57	1.85	0.062	0.073
F	6.60	7.11	0.260	0.280
L	15.11	15.37	0.595	0.605
L2	-	1.40	-	0.055

Design Notes